

Traversing Unit LK3



The LK 3 manual traversing unit can be used as an option for our Control Unit KST31. The traversing unit and the turning device can be conveniently unlocked with just one lever. A floor recessed version and a floor mounted version are available.

Surface treatment:
Primer and textured top coat
Standard color RAL 9011 black or 7035 light gray



	LK3A	-1	-940	-1	-X
Basic unit					
LK3A Traversing unit rotatable, recessed in floor					
LK3B Traversing unit rotatable, mounted on floor					
Rotation unit					
1 Rotatable 90° left, 180° right with detent					
Travel					
940 mm					
Color					
1 RAL 9011 black					
2 RAL 7035 light gray					
Special model					
X Special / customer specified					
X Special painted					

assembly installation

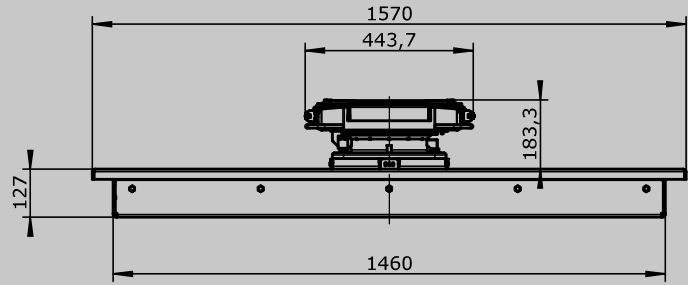
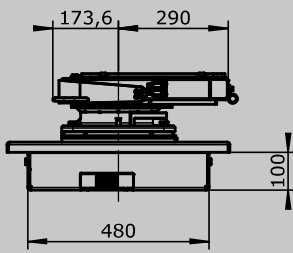

Assembly construction

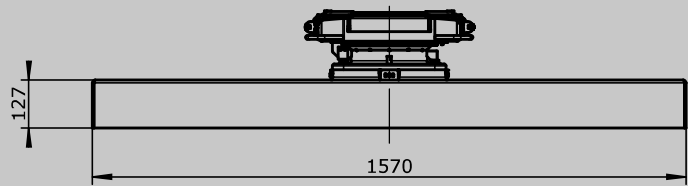
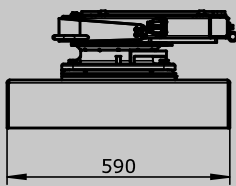

seat mounting

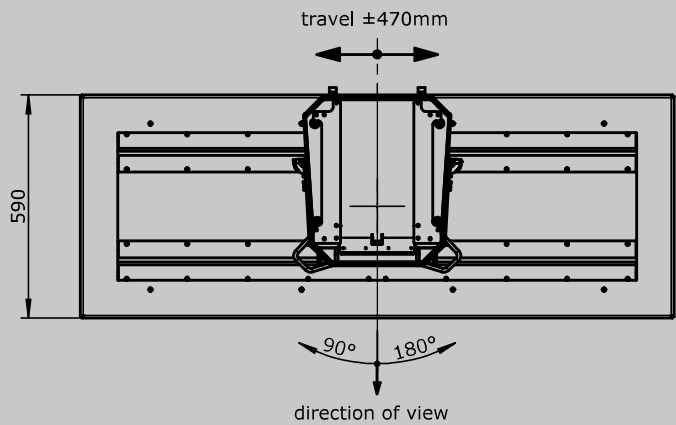
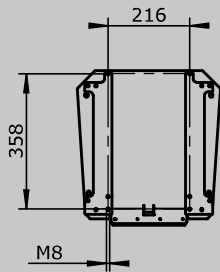

floor mounting

Floor mounting
Assembly installation
M8 countersunk screw

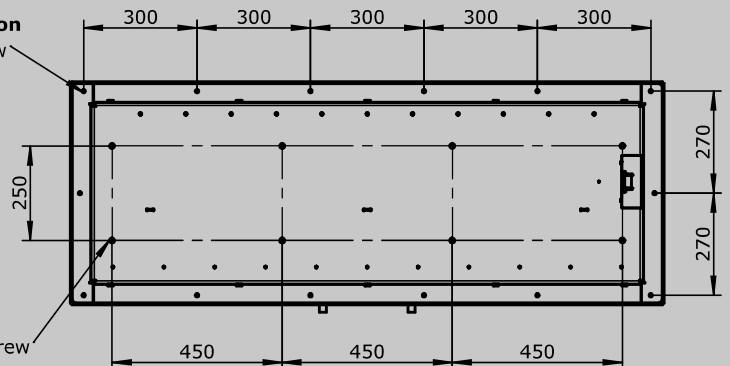

Floor mounting
Assembly construction
Ø13 for M12 cylinderhead screw